

PERSIANA

**SCURO
ALLA
VENETA**

CASSONETTO
MEDITERRANEO

CASSONETTO
RISTRUTTURAZIONE

SISTEMAS DE OSCURECIMIENTO
COMFORT ENTRE TRADICION Y ESTILO



ESPAÑOL

ALPHACAN
INNOVATIVE PROFILES & SOLUTIONS

A MEMBER OF



ALPHAPRO

A photograph of a yellow building facade with several windows and a balcony. The windows have green shutters, some of which are open. The balcony has a white balustrade. The image is used as a background for a text overlay.

CONTRAVENTANA MALLORQUINA

- Sistema de oscurecimiento disponible con lamas fijas o regulables
- Diseño y estética versátiles, adaptable a cualquier contexto arquitectónico y elevada resistencia a los agentes atmosféricos
- Solución técnica creada por Alphacan que garantiza un excelente resultado y facilidad de montaje

SERIE	PROPIEDADES	RESULTADO DEL ENSAYO
PERSIANA	Resistencia a la carga de viento	Clase 6
PERSIANA	Clase de transmisión de la energía solar	Clase 4

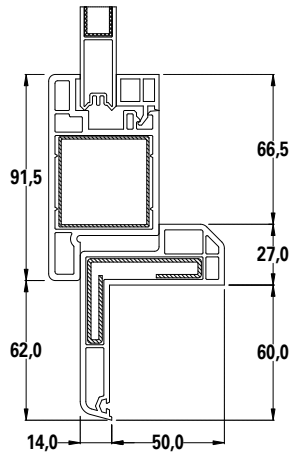
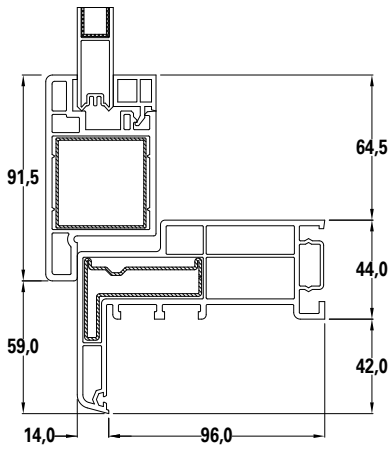
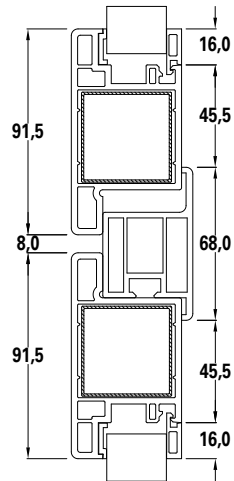
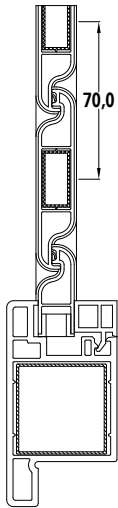

TIPOLOGIAS CONSTRUCTIVAS

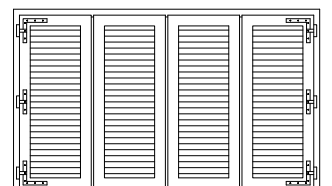
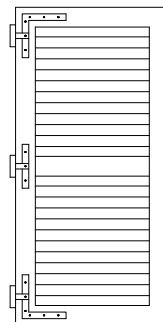
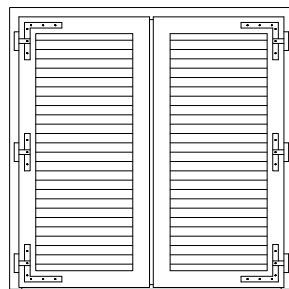
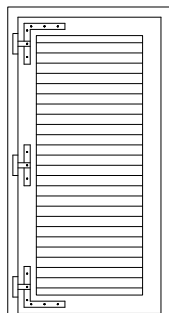
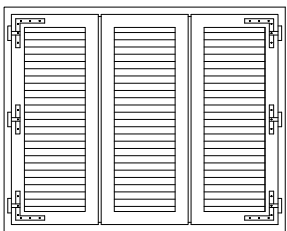



CONTRAVENTANA VENECIANA

- Sistema de oscurecimiento que reproduce construcciones tradicionales regionales
- Sistema de paneles machihembrados verticalmente, sin juntas ni articulaciones intermedias
- Incluye refuerzos metálicos que aportan una mayor estabilidad a la hoja
- El canal en relieve del panel resalta la estética, con un resultado final práctico y eficaz



SERIE	PROPIEDADES	RESULTADO DEL ENSAYO
SCURO	Resistencia a la carga de viento	Clase 6

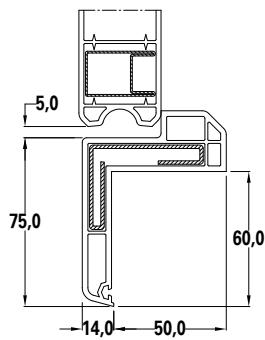
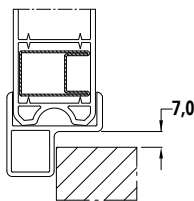
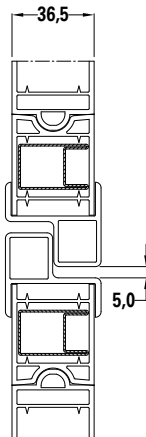
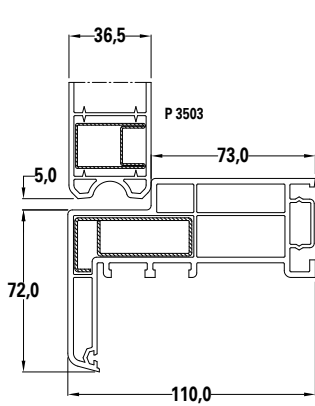

TIPOLOGIAS CONSTRUCTIVAS

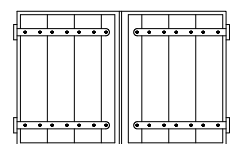
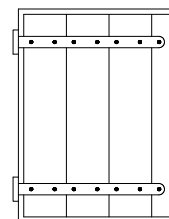
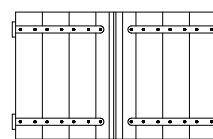
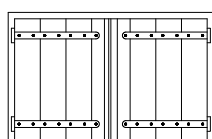
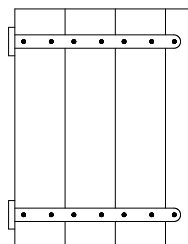
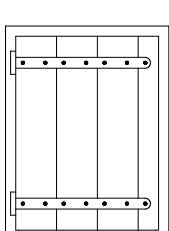



PERSONALIZA
TU AMBIENTE EN
www.alphacan-mydesign.com





Elegantes, resistentes y personalizables

con una amplia gama de colores y acabados de prestigio, los sistemas de oscurecimiento ALPHACAN no necesitan mantenimiento y se adaptan perfectamente a cualquier entorno.

Fabricados con PVC de alta calidad y diseñados de manera innovadora, representan una elección sostenible y duradera, garantizando una protección total contra los elementos atmosféricos y contribuyendo a reducir el gasto energético.





CAJÓN DE PERSIANA MEDITERRÁNEO

- Cajón monobloque ideal para obra nueva
- Altas prestaciones de aislamiento termo-acústico
- Se puede combinar con diferentes tipos de mecanismos de accionamiento, incluso los motorizados

SERIE	PROPIEDADES	TIPOLOGÍA	RESULTADO DEL ENSAYO
CASSONETTO MEDITERRANEO	Transmitancia (U_{SB})	Estándar	2,7 W/m ² K
		Iso	0,99 W/m ² K
	Acústica (R_w)	Estándar	30 dB
		Iso	32 dB

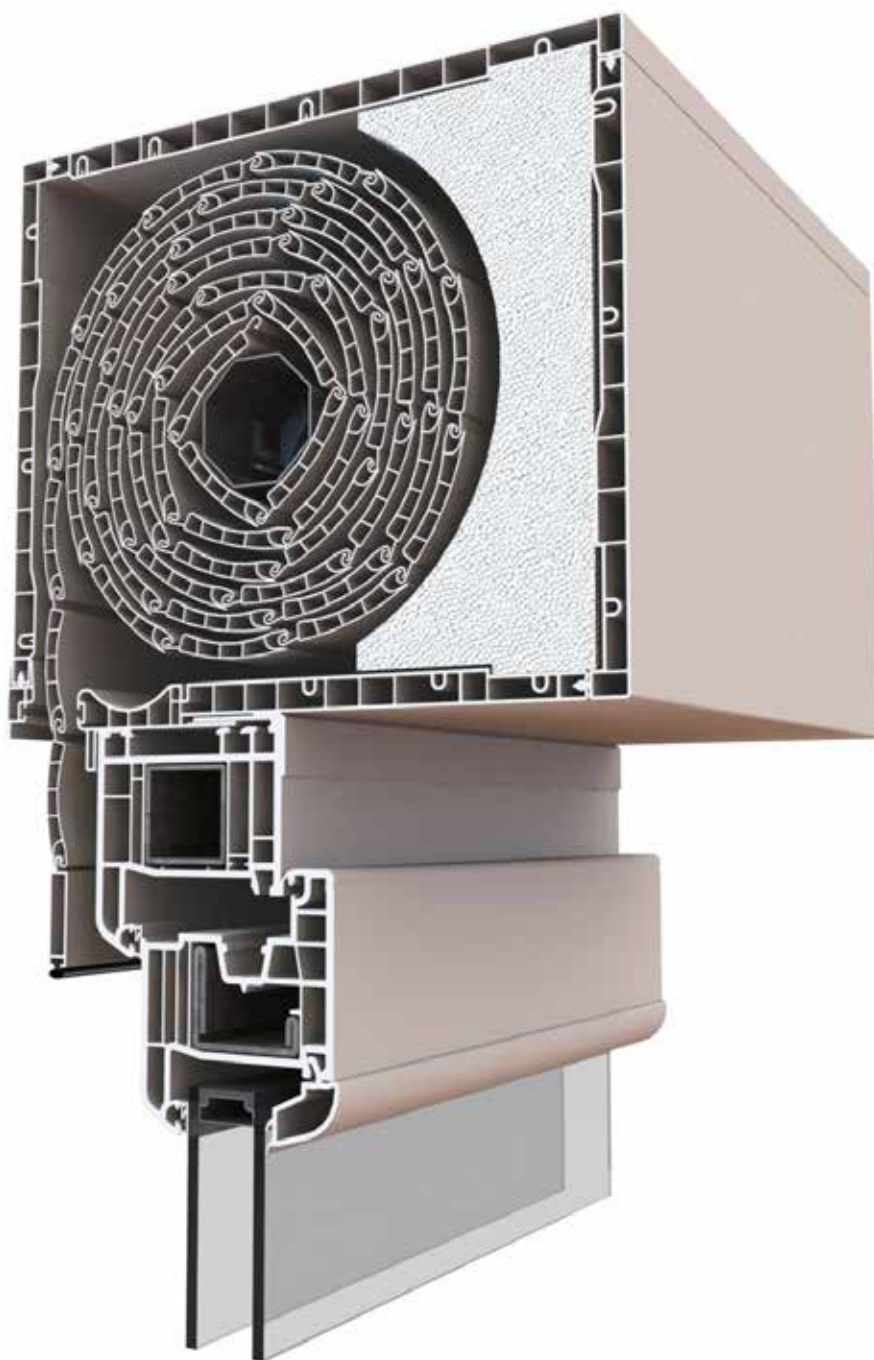
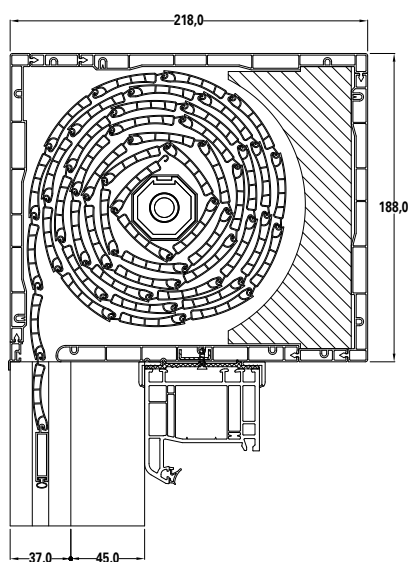
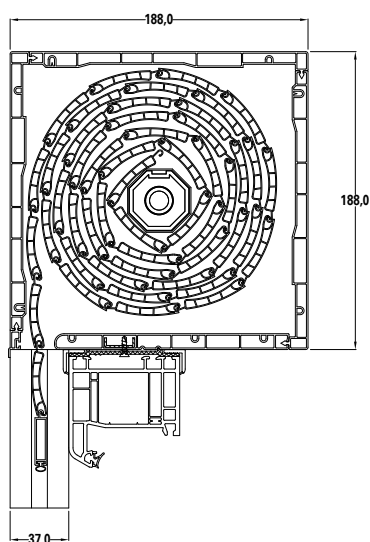



CAJÓN DE PERSIANA PARA REFORMA

- Sistema particularmente indicado para la reforma
- Indicado para alojar persianas incluso de grandes dimensiones, gracias a la especial conformación geométrica de los componentes
- Se combina perfectamente con la ventana, ya que se fabrican con los mismos acabados
- Excelentes prestaciones de aislamiento térmico y acústico



SERIE	PROPIEDADES	TIPOLOGÍA	RESULTADO DEL ENSAYO
CASSONETTO RISTRUTTURAZIONE	Transmitancia (U_{SB})	Frontal XPS 24 mm	1,6 W/m ² K
		Frontal XPS 40 mm	1,4 W/m ² K
		Frontal XPS 24 mm y tapas laterales EPS 20 mm	1,2 W/m ² K
		Frontal XPS 40 mm y tapas laterales EPS 20 mm	1,0 W/m ² K

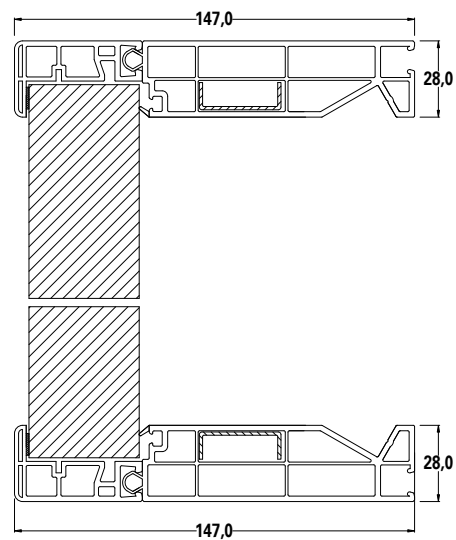
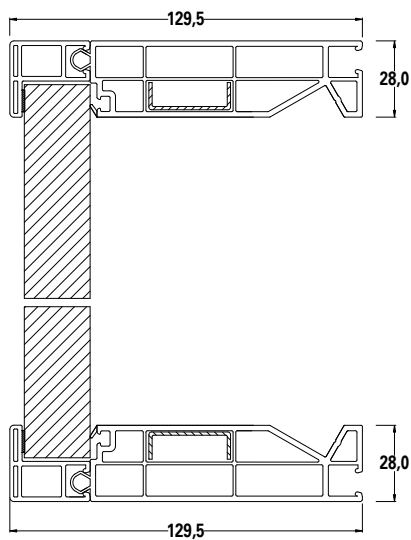



BROSCURES - 2024
Departamento de Marketing y Comunicación de Alphacan - UTBS Alphacan Images

ALPHACAN
INNOVATIVE PROFILES & SOLUTIONS

A MEMBER OF **ALPHAPRO**

Sede y planta de producción
Via San Sisto, 24 -I-38062 Arco (TN)
Tel. +39 0464 587 500

info@alphacan.it www.alphacan.com



PRODUCTOR AUTORIZADO ALPHACAN